

EK 300 IEM



Instruction manual

Tastensymbole / Button icons / Icônes de touches / Simboli dei tasti / Símbolos de las teclas / Toetsymbolen / Símbolos dos botões / Символы кнопок / 按键图标

	<p>Taste ESC / ESC button / Touche ESC / Tasto di ESC / Tecla ESC / Toets ESC / Botão ESC / Кнопка ESC / ESC 键</p>
	<p>ESC drücken / Press the ESC button / Appuyez sur la touche ESC / Premere il tasto di ESC / Pulsar ESC / ESC indrukken / Premir ESC / Нажать ESC / 按 ESC 键</p>
	<p>Taste SET / SET button / Touche SET / Tasto di SET / Tecla SET / Toets SET / Botão SET / Кнопка SET / SET 键</p>
	<p>SET drücken / Press the SET button / Appuyez sur la touche SET / Premere il tasto di SET / Pulsar SET / SET indrukken / Premir SET / Нажать SET / SET 键</p>
	<p>Taste UP/DOWN / UP/DOWN button / Touche UP/DOWN / Tasto UP/DOWN / Tecla UP/DOWN / Toets UP/DOWN / Botão UP/DOWN / Кнопка UP/DOWN / 上下键 UP/DOWN</p>
	<p>Taste UP/DOWN drücken / Press the UP/DOWN button / Appuyer sur la touche UP/DOWN / Tasto UP/DOWN / Pulsar tecla UP/DOWN / De toets UP/DOWN indrukken / Premir o botão UP/DOWN / Нажать кнопку UP/DOWN / 按 UP/DOWN 键</p>

Contents

Important safety instructions	2
The EK 300 IEM G3 diversity receiver	3
Areas of application	3
The frequency bank system	3
Delivery includes	4
Product overview	5
Overview of the EK 300 IEM G3 diversity receiver	5
Overview of the displays	6
Putting the diversity receiver into operation	7
Inserting the batteries/accupack	7
Charging the accupack	7
Connecting the earphones	7
Attaching the diversity receiver to clothing	8
Using the diversity receiver	9
Switching the diversity receiver on/off and adjusting the volume	9
Deactivating the lock mode temporarily	10
Selecting a standard display	10
Using the operating menu	11
The buttons	11
Overview of the operating menu	11
Working with the operating menu	12
Adjusting settings via the operating menu	14
The main menu "Menu"	14
The extended menu "Advanced Menu"	17
Synchronizing an SR 300 IEM G3 transmitter with the diversity receiver	21
Setting the transmitters to intermodulation-free channels (Easy Setup Sync)	21
Synchronizing transmitters with diversity receivers (Sync)	22
Using freely selectable receiving frequencies	22
Cleaning the diversity receiver	23
Recommendations and tips	23
If a problem occurs	24
Specifications	25
Manufacturer Declarations	26



For additional information, visit the EK 300 IEM G3 product page on our website at www.sennheiser.com.

Important safety instructions

- Read this instruction manual.
- Keep this instruction manual. Always include this instruction manual when passing the product on to third parties.
- Heed all warnings and follow all instructions in this instruction manual.
- Use only a cloth for cleaning the product.
- Do not place the product near any heat sources such as radiators, stoves, or other devices (including amplifiers) that produce heat.
- Only use attachments/accessories specified by Sennheiser.
- Refer all servicing to qualified service personnel.
Servicing is required if the product has been damaged in any way, liquid has been spilled, objects have fallen inside, the product has been exposed to rain or moisture, does not operate properly or has been dropped.
- **WARNING:** To reduce the risk of short circuits, do not use the product near water and do not expose it to rain or moisture.
- This product is also intended for professional use. Commercial use is subject to the safety-at-work regulations. Sennheiser, as the manufacturer, is therefore obliged to expressly point out possible health risks arising from use.

This product is capable of producing sound pressure exceeding 85 dB(A). 85 dB(A) is the sound pressure corresponding to the maximum permissible volume which is by law (in some countries) allowed to affect your hearing for the duration of a working day. It is used as a basis according to the specifications of industrial medicine. Higher volumes or longer durations can damage your hearing. At higher volumes, the duration must be shortened in order to prevent hearing damage. The following are sure signs that you have been subjected to excessive noise for too long a time:

- You can hear ringing or whistling sounds in your ears.
- You have the impression (even for a short time only) that you can no longer hear high notes.

Intended use

Intended use of the EK 300 IEM G3 diversity receiver includes:

- having read these instructions especially the chapter “Important safety instructions”,
- using the product within the operating conditions and limitations described in this instruction manual.

“Improper use” means using the product other than as described in this instruction manual, or under operating conditions which differ from those described herein.

The EK 300 IEM G3 diversity receiver

This diversity receiver is part of the evolution wireless series generation 3 (ew G3). With this series, Sennheiser offers high-quality state-of-the-art RF transmission systems with a high level of operational reliability and ease of use. Transmitters and receivers are designed for monitoring applications and permit wireless transmission with studio-quality sound.

Features of the evolution wireless 300 IEM G3 series:



- Optimized PLL synthesizer and microprocessor technology
- HDX noise reduction system
- Adaptive diversity technology
- Switching bandwidth of 42 MHz
- Scan function (Easy Setup) for scanning the frequency banks for unused channels
- Adjustable and switchable limiter

Adaptive diversity

This diversity receiver uses the ground connection of the earphones cable as its second antenna to provide improved reception.

Areas of application

The receiver can be combined with the SR 300 IEM G3 transmitter.

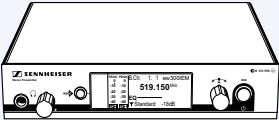
Diversity receiver	Earphones	Transmitter
EK 300 IEM G3	IE 4	SR 300 IEM G3
		

This transmitter is available in the same UHF frequency ranges and is equipped with the same frequency bank system with factory-preset frequencies. An advantage of the factory-preset frequencies is that

- a transmission system is ready for immediate use after switch-on,
- several transmission systems can be operated simultaneously on the preset frequencies without causing intermodulation interference.

The frequency bank system

The diversity receiver is available in 7 UHF frequency ranges with 1,680 receiving frequencies per frequency range:

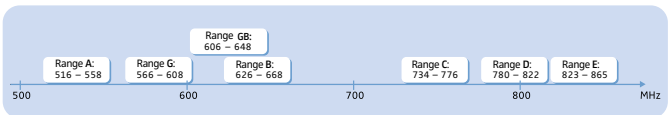

Delivery includes

Each frequency range (A–E, G, GB) offers 26 frequency banks with up to 16 channels each:

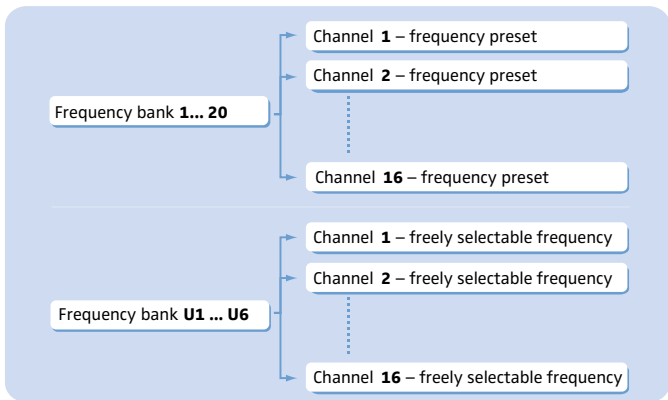

Each of the channels in the frequency banks “1” to “20” has been factory-preset to a fixed frequency (frequency preset). The factory-preset frequencies within one frequency bank are intermodulation-free. These frequencies cannot be changed.

For an overview of the frequency presets, please refer to the supplied frequency information sheet. Updated versions of the frequency information sheet can be downloaded from the EK 300 IEM G3 product page on our website at www.sennheiser.com.

The frequency banks “U1” to “U6” allow you to freely select and store frequencies. It might be that these frequencies are **not** intermodulation-free (see page 21).

Delivery includes

The packaging contains the following items:

- 1 EK 300 G3 IEM diversity receiver
- 2 AA size batteries, 1.5 V
- 1 pair of IE 4 earphones
- 1 instruction manual
- 1 frequency information sheet

Product overview

Overview of the EK 300 IEM G3 diversity receiver

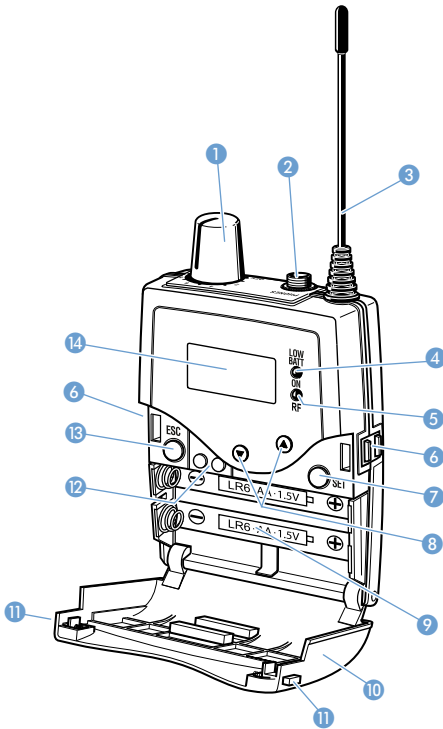

- 1 On/off/volume control
- 2 3.5 mm stereo jack socket (PHONES), lockable (the ground contact is used by antenna II)
- 3 Antenna I
- 4 Operation and battery status indicator, red LED
lit = ON
flashing = LOW BATT
- 5 RF signal indication, green LED
lit = RF
- 6 Charging contacts
- 7 SET button
- 8 UP/DOWN button ▲/▼
- 9 Battery compartment
- 10 Battery compartment cover
- 11 Battery compartment catches
- 12 Infra-red interface
- 13 ESC button
- 14 Display panel, backlit in orange

Overview of the displays

After switch-on, the diversity receiver displays the “Frequency/Name” standard display. For further illustrations and examples of the different standard displays, refer to page 10.

The display backlighting is automatically reduced after approx. 20 seconds.

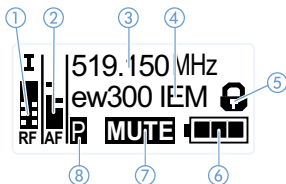

Display	Meaning
① RF level “RF” (Radio Frequency)	<p>Diversity display:</p> <ul style="list-style-type: none"> I Antenna input I is active II Antenna input II is active <p>RF signal level: Field strength of the received signal Squelch threshold level</p>
② Audio level “AF” (Audio Frequency)	<p>Peak hold function Modulation of the transmitter (channel-separated when the transmitter is set to stereo mode)</p> <p>When the display shows full deflection, the audio input level is excessively high.</p>
③ Frequency	Current receiving frequency (see page 17)
④ Name	Freely selectable name of the receiver (see page 15)
⑤ Lock mode icon	Lock mode is activated (see page 10)
⑥ Battery status	<p>Charge status:</p> <ul style="list-style-type: none"> approx. 100% approx. 70% approx. 30% charge status is critical, the red LOW BATT LED ④ is flashing:
⑦ Muting function “MUTE”	<p>“Mute” is only displayed on the “Frequency/Name” standard display (see page 10)</p> <ul style="list-style-type: none"> when the transmitter’s RF signal is deactivated or when the transmitter is set to mono mode and therefore does not transmit a pilot tone but the receiver’s pilot tone evaluation is activated.
or audio channels	<p>The audio channels are only displayed on the “Frequency/Limiter” and “Frequency/High Boost” standard displays (see page 10)</p> <ul style="list-style-type: none"> Stereo Focus
⑧ Pilot tone “P”	Activated pilot tone evaluation (see page 18)

Putting the diversity receiver into operation

Inserting the batteries/accupack

For powering the diversity receiver, you can either use two 1.5 V AA size batteries or the rechargeable Sennheiser BA 2015 accupack (optional accessory).

- ▶ Open the battery compartment by pushing the two catches 11 in the direction of the arrows and open the cover 10.

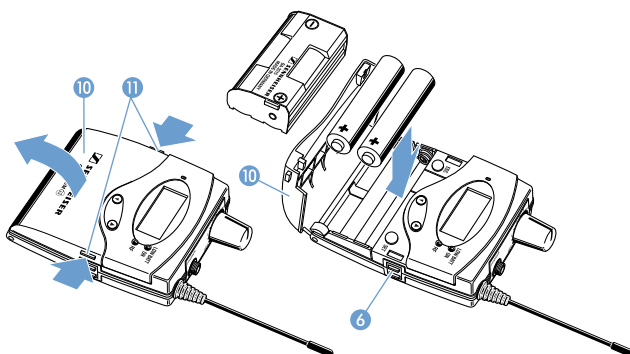

- ▶ Insert the two batteries or the accupack as shown above. Observe correct polarity when inserting the batteries/accupack.
- ▶ Close the battery compartment by pressing on the center of the cover 10. The battery compartment cover 10 locks into place with an audible click.

Charging the accupack

To charge the BA 2015 accupack (optional accessory) installed in the diversity receiver:

- ▶ Insert the diversity receiver into the L 2015 charger (optional accessory).



The L 2015 charger can only charge the combination BA 2015 accupack/diversity receiver. Standard batteries (primary cells) or individual rechargeable battery cells cannot be charged.

Connecting the earphones

- ▶ Connect the earphones to the socket 2.

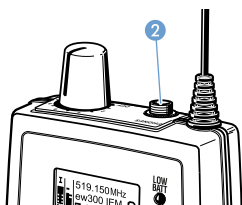

The ground connection of the earphones cable serves as the antenna for the second diversity section. For details on the connector assignment, refer to the diagram on page 26.

Attaching the diversity receiver to clothing

You can use the belt clip 15 to attach the diversity receiver to clothing (e.g. belt, waistband).

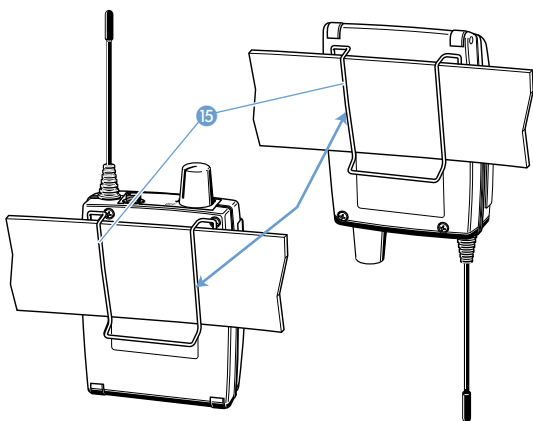

The belt clip is detachable so that you can also attach the diversity receiver with the antenna pointing downwards. To do so, withdraw the belt clip from its fixing points and attach it the other way round. The belt clip is secured so that it cannot slide out of its fixing points accidentally.

To detach the belt clip:

- ▶ Lift one side of the belt clip as shown.

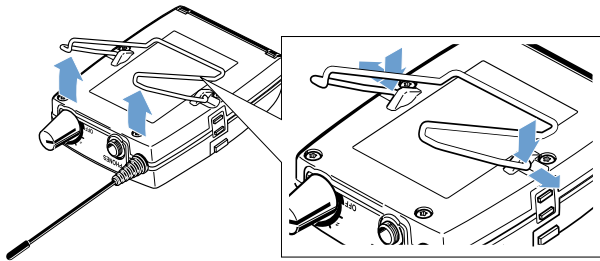

- ▶ Press down the belt clip at one fixing point and pull it out of the receiver housing.
- ▶ Repeat for the other side.

Using the diversity receiver

To establish a transmission link, proceed as follows:

1. Switch the transmitter on (see the instruction manual of the transmitter).
2. Switch the diversity receiver on (see next section).
The transmission link is established and the receiver's RF level display "RF" ① reacts.



It is vital to observe the notes on frequency selection on page 21.

If you cannot establish a transmission link between transmitter and receiver, read the chapter "Synchronizing an SR 300 IEM G3 transmitter with the diversity receiver" on page 21.

Switching the diversity receiver on/off and adjusting the volume

To switch the diversity receiver **on**:

- ▶ Turn the volume control ① clockwise until it clicks.
The red **ON** LED ④ lights up. The "Frequency/Name" standard display appears on the display panel.

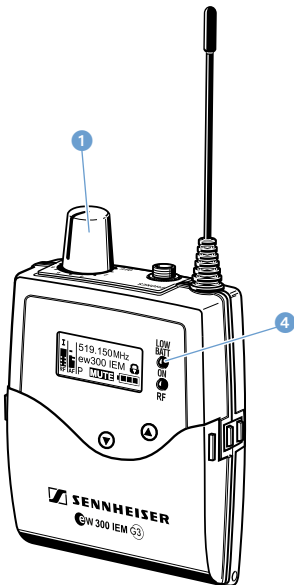

To switch the diversity receiver **off**:

- ▶ Turn the volume control ① counterclockwise until it clicks.
The red **ON** LED ④ goes off and the diversity receiver switches off.

To adjust the **volume**:

CAUTION!

Hearing damage due to high volumes!





Listening at high volume levels for long periods can lead to permanent hearing defects.

- ▶ Set the volume to a low level before putting the earphones on.
- ▶ Do **not** continuously expose yourself to high volumes.

- ▶ Turn the volume control ①.

Deactivating the lock mode temporarily

You can activate or deactivate the automatic lock mode via the “Auto Lock” menu item (see page 16). If the lock mode is activated, you have to temporarily deactivate it in order to be able to operate the receiver:

- 
 - ▶ Press the **SET** button.
“Locked” appears on the display panel.
- 
 - ▶ Press the UP/DOWN button ▲/▼.
“Unlock?” appears on the display panel.
- 
 - ▶ Press the **SET** button.
 - When you are in the operating menu, the lock mode remains deactivated until you exit the operating menu.
 - When one of the standard displays is shown, the lock mode is automatically activated after 10 seconds.

The lock mode icon ⑤ flashes prior to the lock mode being activated again.



Selecting a standard display

- 
 - ▶ Press the **ESC** button to select a standard display. In stereo mode (see page 16), you can alternatively press the UP/DOWN button ▲/▼.



Contents of the display	Selectable standard display
	“Frequency/Name” with “MUTE” display ⑦
	“Frequency/Limiter” with display of the audio channels (Stereo/Focus) ⑦
	“Frequency/High Boost” with display of the audio channels (Stereo/Focus) ⑦

For more detailed information, refer to the chapter “Overview of the displays” on page 6.

Using the operating menu

A special feature of the Sennheiser ew G3 series is the consistent, intuitive menu structure of transmitters and receivers. As a result, adjustments to the settings can be made quickly – even in stressful situations, for example on stage or during a live show or presentation.

The buttons

Button	Function of the button
Press the ESC button 	<ul style="list-style-type: none"> • Selects a standard display (see page 10) • Cancels the entry and returns to the current standard display (ESC function)
Press the SET button 	<ul style="list-style-type: none"> • Changes from the current standard display to the operating menu • Calls up a menu item • Enters a submenu • Stores the settings and returns to the operating menu
Press the UP/DOWN button ▲/▼ 	<ul style="list-style-type: none"> • In Focus mode: Adjusts the balance (see page 15) • In stereo mode: Selects a standard display (see page 10) • Changes to the next/previous menu item • Changes the setting of a menu item

Overview of the operating menu

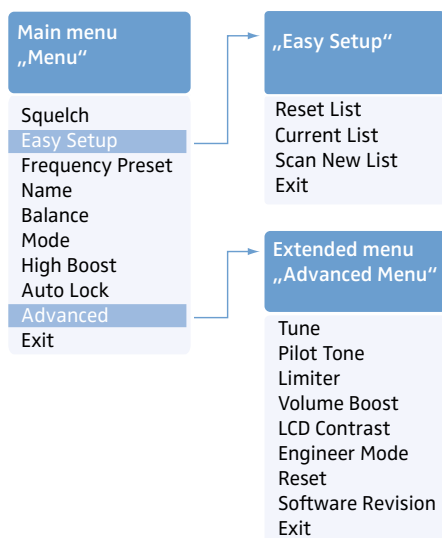

Display	Function of the menu item	Page
Main menu "Menu"		14
Squelch	Adjusts the squelch threshold	14
Easy Setup	Scans for unused frequency presets, releases and selects frequency presets	14
Frequency Preset	Sets the frequency bank and the channel	15
Name	Enters a freely selectable name	15
Balance	Adjusts the balance	14
Mode	Selects stereo or Focus mode	14
High Boost	Activates/deactivates the treble boost	16
Auto Lock	Activates/deactivates the automatic lock mode	16
Advanced	Calls up the extended menu "Advanced Menu"	17
Exit	Exits the operating menu and returns to the current standard display	–

Display	Function of the menu item	Page
“Easy Setup”		14
Reset List	Releases all locked frequency presets	14
Current List	Selects an unused frequency preset	14
Scan New List	Scans for unused receiving frequencies (frequency preset scan)	14
Exit	Exits “Easy Setup” and returns to the main menu	–
Extended menu “Advanced Menu”		17
Tune	Sets the receiving frequencies for the frequency banks “U1” to “U6”	17
	Sets the channel and the receiving frequency for the frequency banks “U1” to “U6”	18
Pilot Tone	Activates/deactivates the pilot tone evaluation	18
Limiter	Adjusts the limiter	18
Volume Boost	Adjusts the volume boost	19
LCD Contrast	Adjusts the contrast of the display panel	19
Engineer Mode	Adjusts the menu item and loading profiles	19
Reset	Resets the settings made in the operating menu	20
Software Revision	Displays the current software revision	20
Exit	Exits the extended menu “Advanced Menu” and returns to the main menu	–

Working with the operating menu



If the lock mode is activated, you have to deactivate it in order to be able to work with the operating menu (see page 10).

By way of example of the “Frequency Preset” menu, this section describes how to use the operating menu.

Changing from a standard display to the operating menu



- ▶ Press the **SET** button.
The current standard display is replaced by the main menu.
The last called up menu item is displayed.





Selecting a menu item

- ▼ ▲ ▶ Press the UP/DOWN button ▲/▼ to change to the “Frequency Preset” menu item.
The current setting of the selected menu item is displayed:

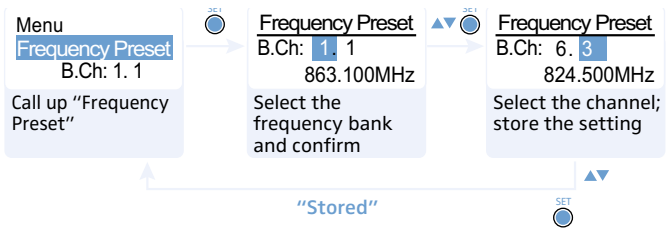
Menu
Frequency Preset
 B.Ch: 1. 1

Changing and storing settings



-  ▶ Press the **SET** button to call up the menu item.
-  ▶ Press the UP/DOWN button **▲/▼** to set the frequency bank.
-  ▶ Press the **SET** button to confirm your selection.
-  ▶ Press the UP/DOWN button **▲/▼** to set the channel.
-  ▶ Press the **SET** button to store the setting.

Canceling an entry

-  ▶ Press the **ESC** button to cancel the entry.
The current standard display appears on the display panel.

To subsequently return to the last edited menu item:

-  ▶ Press the **SET** button repeatedly until the last edited menu item appears.

Exiting a menu item

-  ▶ Change to the "Exit" menu item.

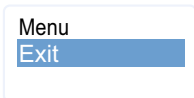

-  ▶ Confirm your selection.
You return to the next higher menu level or you exit the operating menu and return to the current standard display.

To directly return to the current standard display:

-  ▶ Press the **ESC** button.

Adjusting settings via the operating menu

The main menu “Menu”

Adjusting the squelch threshold – “Squelch”

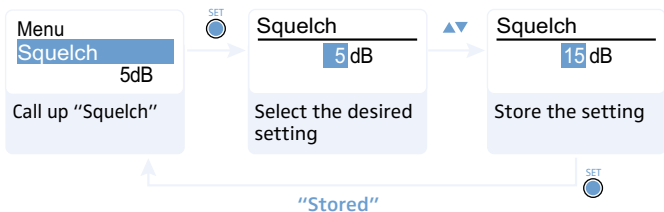

Adjustment range: 5 to 25 dBµV, adjustable in 2-dB steps, can be switched off

The squelch eliminates annoying noise when the transmitter is switched off or when there is no longer sufficient transmitter power received by the receiver.

CAUTION!

Danger of hearing damage!



If you switch the squelch off or adjust the squelch threshold to a very low value, loud hissing noise can occur in the receiver. The hissing noise can be loud enough to cause hearing damage!

- ▶ Always make sure that the squelch is switched on.
- ▶ Before adjusting the squelch threshold, set the volume of the headphone output **PHONES** to the minimum (see page 9).
- ▶ Never change the squelch threshold during a live transmission.

- ▶ Adjust the squelch threshold – with the transmitter switched off – to the lowest possible setting that suppresses hissing noise.



A high squelch threshold reduces the transmission range.

The squelch should only be switched off for servicing purposes. With the squelch threshold set to “5 dB”, you switch the squelch off by keeping the DOWN button ▼ pressed for 3 seconds.

Display	Squelch is ...
	... switched on. The dotted line ⑩ displays the squelch threshold.
	... switched off. The dotted line ⑩ goes off and the audio level display “AF” shows full deflection (hissing noise).

If you have accidentally switched off the squelch:

- ▶ Press the UP button ▲ to switch the squelch on.

Scanning for, releasing and selecting frequency presets – “Easy Setup”

Menu item	Function of the menu item
Reset List	Releases all locked frequency presets
Current List	Selects an unused frequency preset
Scan New List	Automatically scans for unused receiving frequencies (frequency preset scan). If receiving frequencies are used, they will be locked; if receiving frequencies are unused, they will be released. After the frequency preset scan, you can select an unused frequency preset.

Setting the frequency bank and the channel – “Frequency Preset”

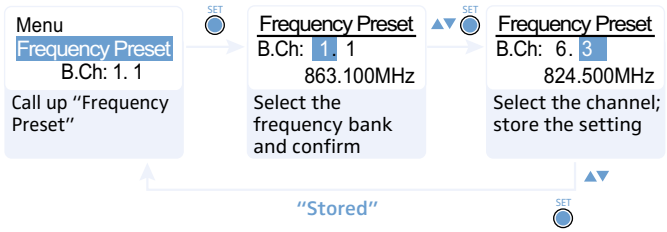

When setting up multi-channel systems, please observe the following:

Only the factory-preset receiving frequencies within one frequency bank (“1” to “20”) are intermodulation-free. It is vital to observe the notes on frequency selection on page 21.

Overview of the frequency banks and channels:

Frequency bank	Channels	Type
“1” to “20”	up to 16 per frequency bank	System bank: frequencies are factory-preset
“U1” to “U6”	up to 16 per frequency bank	User bank: frequencies are freely selectable

Entering a name – “Name”

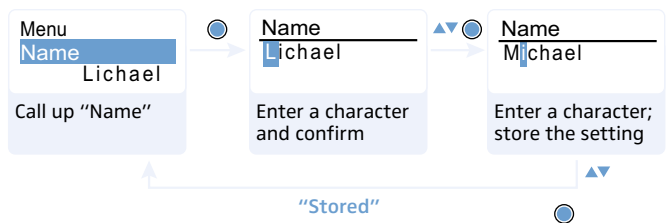

Via the “Name” menu item, you can enter a freely selectable name (e.g. the name of the performer) for the receiver. The name is displayed on the “Frequency/Name” standard display (see page 10). The name can consist of up to 8 characters such as:

- letters (without pronunciation marks),
- numbers from 0 to 9,
- special characters and spaces.

To enter a name, proceed as follows:

- ▼▲ ▶ Press the UP/DOWN button ▲/▼ to select a character.
- SET ▶ Press the SET button to change to the next segment/character or to store the complete entry.

Adjusting the balance – “Balance”

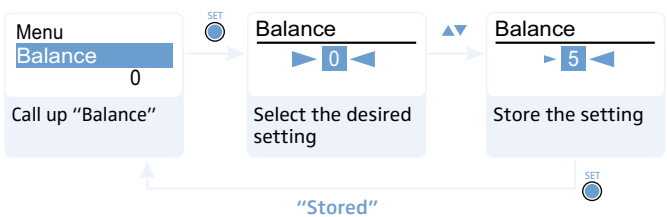

You can adjust the balance in 31 steps. In Focus mode (see next section) and when one of the standard displays is shown, you can also use the UP/DOWN button ▲/▼ to adjust the balance. The mode of operation of the balance setting depends on the selected audio mode (see next section).

Switching between "Stereo" and "Focus" mode – "Mode"

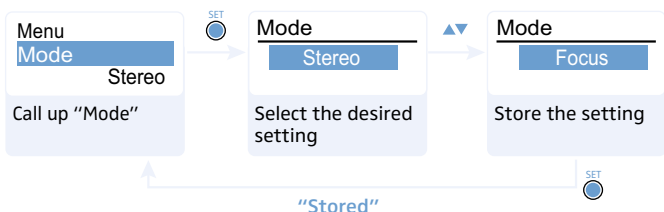

The selected audio mode influences the mode of operation of the balance setting (see previous section).

Audio mode	
Stereo	Focus
The left-right signals are available as usual. The balance setting serves to adjust the balance between the left and right stereo signal.	The left-right signals are mixed and are available as a mono signal in both headphone channels. The balance setting serves to adjust the relative levels of the two separate channels in the mixed mono signal.
In both audio modes, the corresponding transmitter has to be set to stereo mode!	

Activating/deactivating the treble boost – "High Boost"

Via the "High Boost" menu item, you can boost the treble response of the output signal (8 dB at 10 kHz).

Output signal remains unchanged	High Boost activated
EQ	EQ

Activating/deactivating the automatic lock mode – "Auto Lock"

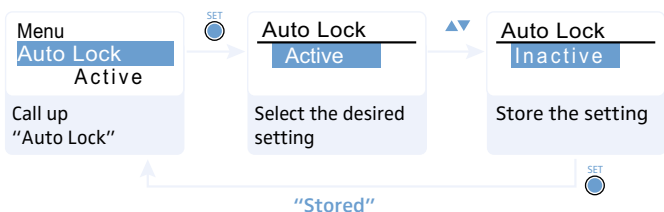

The lock mode prevents that the balance is accidentally adjusted when the receiver is in Focus mode. The lock mode icon on the current standard display indicates that the lock mode is activated. For information on how to use the lock mode, refer to page 10.

The extended menu “Advanced Menu”

To get into the extended menu “Advanced Menu”:

- ▶ From the main menu, select “Advanced”.

Setting the receiving frequencies and the frequency banks “U1” to “U6 – “Tune”



When you have selected one of the system banks and then select the “Tune” menu, the diversity receiver automatically switches to channel 1 of the frequency bank “U1”. In this case, “U1.1” briefly appears on the display panel.

Upon delivery, the channels of the frequency banks “U1” to “U6” are not assigned a receiving frequency.

Via the “Tune” menu item, you can:

1. set a receiving frequency to be stored in the current channel of the selected frequency bank (“U1” to “U6”) or
2. first select a frequency bank (“U1” to “U6”) and a channel and then assign this channel a receiving frequency.

Setting a receiving frequency for the current channel

- ▼ ▲ ▶ Press the UP/DOWN button ▲/▼ until the “Tune” menu item appears.



- ▶ Press the SET button.

The MHz section of the receiving frequency of the channel is highlighted.

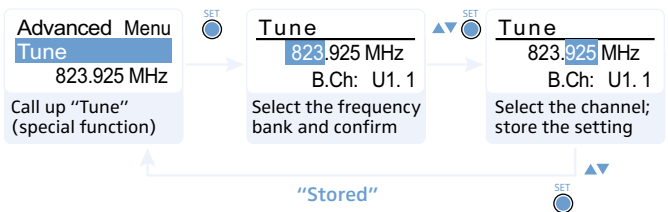

It is vital to observe the notes on frequency selection on page 21.

- ▼ ▲ ▶ Press the UP/DOWN button ▲/▼ to set the MHz section of the frequency.



- ▶ Press the SET button to confirm the MHz section of the frequency.

The kHz section of the frequency is highlighted.

- ▼ ▲ ▶ Press the UP/DOWN button ▲/▼ to set the kHz section of the frequency.



- ▶ Press the SET button to confirm the frequency.

“Stored” appears on the display panel. The “Tune” menu item appears again.

Selecting a channel and assigning this channel a frequency

▼▲ ▶ Press the UP/DOWN button ▲/▼ until the "Tune" menu item appears.

SET ▶ Press the SET button and keep it pressed until the frequency bank is highlighted.

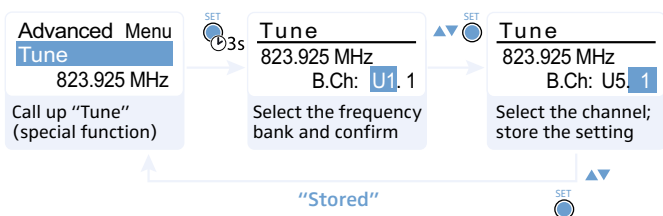

▼▲ ▶ Press the UP/DOWN button ▲/▼ to set the frequency bank.

SET ▶ Press the SET button to confirm the frequency bank. The channel is highlighted.

▼▲ ▶ Press the UP/DOWN button ▲/▼ to set the channel.

SET ▶ Press the SET button to confirm the channel. The frequency (MHz section) is highlighted.

▶ Set the desired frequency (MHz and kHz section) as described in the previous chapter.

Activating/deactivating the pilot tone evaluation – "Pilot Tone"

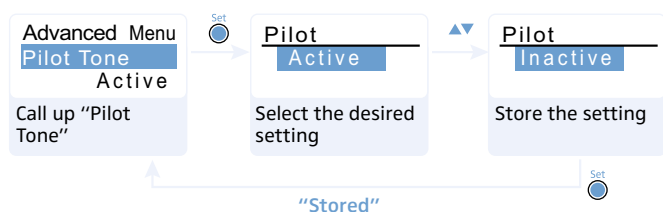

The pilot tone encodes the stereo signal of the transmitter and supports the diversity receiver's squelch function, thus protecting against interference due to RF signals from other devices. When set to stereo operation, the transmitter adds an inaudible pilot tone to the transmitted stereo signal. The receiver detects and evaluates the pilot tone.

▶ When the transmitter is set to mono operation, deactivate the pilot tone evaluation.

Display	Meaning
No icon	The pilot tone evaluation is deactivated.
P	The pilot tone evaluation is activated. The receiver does not receive a pilot tone because the transmitter operates in mono mode.
P	The pilot tone evaluation is activated. The receiver receives a pilot tone.

Adjusting the limiter – "Limiter"

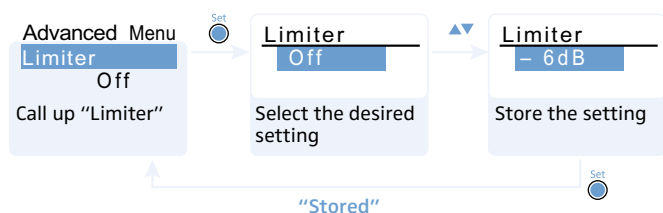

CAUTION! Danger of hearing damage due to a switched-off limiter!

The limiter limits the volume at the headphone output PHONES and thus protects your hearing. With the limiter switched off, the receiver is capable of producing high sound pressure levels. Prolonged exposure to high sound pressure levels can cause permanent hearing defects.

- ▶ Set the limiter to a low level before putting the earphones on.
- ▶ Do **not** continuously expose yourself to high volumes.

You can adjust the limiter in 6-dB steps from -18 dB to -6 dB or switch it off (OFF).

Adjusting the volume boost – “Volume Boost”

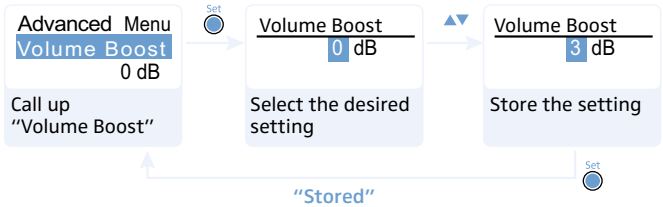

Adjustment range: 0 dB, +3 dB or +6 dB

To adjust the volume boost:

- ▶ Call up the “Volume Boost” menu item.
- ▶ Choose the desired setting. Make sure the audio signal will not be distorted.
- ▶ Store your setting.

Adjusting the contrast of the display panel – “LCD Contrast”

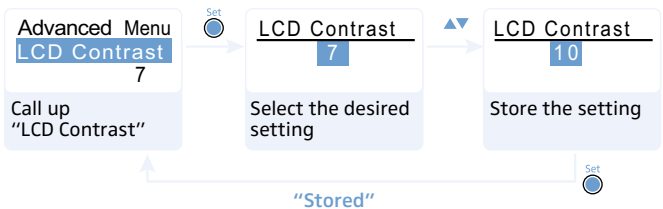

You can adjust the contrast of the display panel in 16 steps.

Adjusting the menu item and loading profiles – “Engineer Mode”

In “Engineer Mode”, you can read out the settings of other EK receivers and save these settings in profiles using your EK 300 IEM G3 receiver.

These profiles can be loaded during a live transmission in order to monitor and, if necessary, adjust an audio signal reproduced by a read-out EK receiver.

A profile contains the settings of the menu items “Frequency Preset”, “Name”, “Squelch”, “Mode”, “Balance”, “Tune”, “Limiter”, “Volume Boost” and “High Boost”.

Menu item	Function of the menu item
“Profiles List”	Creates up to 16 profiles and reads out the settings of the different EK receiver.
“Load Profiles”	Activates/deactivates the loading of profiles
“Clear List”	Deletes all profiles
“Exit”	Returns to the “Engineer Mode” menu item

Reading out settings and saving them in profiles

- ▶ From the “Advanced Menu”, call up “Engineer Mode”.
- ▶ Call up the “Profiles List” menu item.
- ▶ Select an unused profile (a profile without frequency entry).
- ▶ Press the SET button. “sync” appears on the display panel of the receiver.
- ▶ Place the receiver’s infra-red interface in front of the infra-red interface of another EK receiver.
The settings of the receiver are assigned to the selected profile.
- ▶ Repeat this procedure to create profiles of other EK receivers.



- You can read out the data of an SR 300 IEM transmitter in the same way. Please note, however, that these settings will only be up-to-date if transmitter and receiver have been synchronized before (“Easy Setup Sync” or “Sync”, see the instruction manual of the EK receiver).
- When the factory default settings are restored (Reset), all profiles are deleted.

Using saved profiles

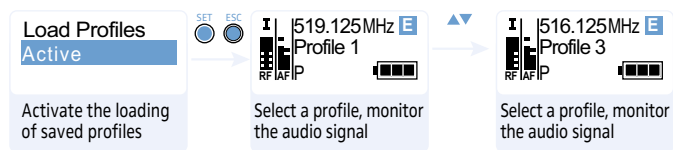

- ▶ From the “Engineer Mode” submenu, call up the “Load Profiles” menu item.
- ▶ Select “Active” to activate the loading of the profiles. “E” appears on the standard display.
- ▶ Select a profile by pressing the UP/DOWN button ▲/▼ when the standard display is shown.
The selected profile is loaded, you hear the audio signal of the corresponding receiver.



- If there is no profile saved, “Inactive” appears in the “Load Profiles” menu item.
- The “Engineer Mode” remains activated, even if you replace the batteries or switch the EK off and on again.

Resetting the settings made in the operating menu – “Reset”

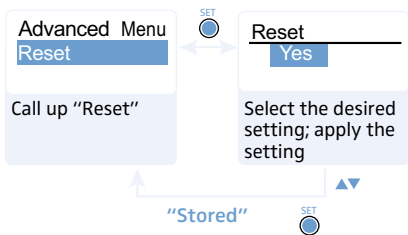

When resetting the settings made in the operating menu, only the selected settings for the pilot tone and for the frequency banks “U1” to “U6” remain unchanged. For an overview of the factory-preset default settings, refer to the enclosed frequency information sheet.

Displaying the software revision – “Software Revision”

You can display the current software revision of the diversity receiver.

Synchronizing an SR 300 IEM G3 transmitter with the diversity receiver



When synchronizing the SR 300 IEM G3 transmitter with a diversity receiver, please observe the following:

- ▶ Only use a transmitter and a diversity receiver from the same frequency range (see the type plates on the transmitter and the diversity receiver).
- ▶ Make sure that the desired frequencies are listed in the enclosed frequency information sheet.
You can also contact your Sennheiser partner who will be pleased to calculate intermodulation-free frequencies for you.
- ▶ Make sure that the desired frequencies are approved and legal in your country and, if necessary, apply for an operating license.
- ▶ The frequency information sheet can also be downloaded from the EK 300 IEM G3 product page at www.sennheiser.com.

Synchronization allows you to quickly and easily transfer transmitter and receiver settings from one device to the other, especially if you want to set up a multi-channel system. There are two transfer directions:

1. **Easy Setup Sync:** Transfer from the receiver to one or several transmitters

Once you have performed a frequency preset scan with a receiver, you use the **Easy Setup Sync** function to transfer unused frequency presets from the receiver to the transmitters. In order to set up a multi-channel system, you use the diversity receiver to transfer the unused channels from the selected frequency bank one after the other to the transmitters, thus ensuring that all transmitters of a multi-channel system operate on intermodulation-free frequencies.

2. **Sync:** Transfer from a transmitter to a receiver

Once you have selected and set the desired receiver settings on the transmitter (either manually or using the **Easy Setup Sync** function), you transfer these settings to a receiver. This configures the receiver and establishes a transmission link between transmitter and receiver.

When carrying out the **Sync** function, the transmitter's current frequency bank and channel setting as well as the receiver parameters adjusted via the **"Sync Settings"** submenu are transferred to the EK 300 IEM G3 receiver via the infra-red interface.

Setting the transmitters to intermodulation-free channels (**Easy Setup Sync**)

Upon delivery, the SR 300 IEM G3 transmitter and the diversity receiver are synchronized with each other. If, however, you cannot establish a transmission link between transmitter and diversity receiver, you first have to use the diversity receiver to determine intermodulation-free channels and then transfer these channels to the transmitters. In doing so, no transmission links are established.

- ▶ On all transmitters, call up the **"Easy Setup"** menu item.
"Easy Setup Sync" appears on the display panels of the transmitters. The RF signals of the transmitters are deactivated. The transmitters await the transfer of a channel and a frequency bank via their infra-red interfaces.
- ▶ With a diversity receiver, perform a frequency preset scan to scan the frequency banks for unused channels (**"Scan New List"**, see page 14).
- ▶ Select a frequency bank with a sufficient number of unused channels and a channel on this receiver (**"Current List"**, see page 14).

- ▶ Start the Easy Setup Sync function by placing the infra-red interface of this diversity receiver in front of the infra-red interfaces ④ of all transmitters, one after the other.

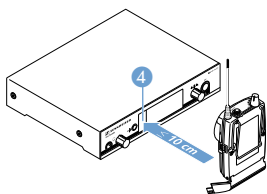

The diversity receiver transfers an unused channel from the selected frequency bank to the first transmitter and the next unused channel to the second transmitter and so on. As soon as a transfer is completed, the display panel of the transmitter displays the numbers of the transferred frequency bank and channel.

Synchronizing transmitters with diversity receivers (Sync)

In a second step, you transfer the frequency bank and channel settings from the transmitters to other diversity receivers (synchronization) and thus establish the transmission links.

If you want to carry out synchronization at a later time:

- ▶ Press the jog dial on the transmitter.
The frequency bank and the channel are stored. The transmitter's RF signal is activated again. You can synchronize this transmitter with a diversity receiver at any time (see the instruction manual of the transmitter).

To carry out synchronization immediately:

- ▶ Start the Sync function by placing the infra-red interface of the first diversity receiver in front of the infra-red interface ④ of the first transmitter while simultaneously pressing the SYNC button ③ on the transmitter.

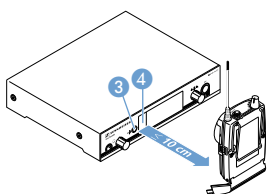

The diversity receiver is set to the same frequency bank and channel as the transmitter. The transmitter's RF signal is activated again. A transmission link is established between the first transmitter and the first diversity receiver.

- ▶ Synchronize each of the remaining transmitters with one of the remaining diversity receivers.
Your multi-channel monitoring system is now ready for operation.

Instead of synchronizing, you can manually set the transmitters to the same frequency bank and channel that you set on the corresponding diversity receivers.

Using freely selectable receiving frequencies

You can also freely select the receiving frequencies and store these frequencies in the frequency banks "U1" to "U6".



It might be that the freely selected frequencies are not intermodulation-free

If you are using frequencies from the frequency banks "U1" to "U6", it might be that the receiving frequencies are not intermodulation-free.

- ▶ Contact your Sennheiser partner who will be pleased to calculate intermodulation-free frequencies for you (see www.sennheiser.com).

- ▶ Set each diversity receiver to the same frequency bank ("U1" to "U6").

- ▶ On one of the receivers, select a channel within this frequency bank and assign this channel a receiving frequency (see page 18).
 - ▶ Synchronize a transmitter with this receiver (see the instruction manual of the transmitter).
- OR:
- ▶ Manually set the transmitter to the same frequency bank and channel that you set on the receiver.
 - ▶ Repeat for the remaining transmitters and receivers as described above.

Cleaning the diversity receiver

CAUTION! Liquids can damage the electronics of the diversity receiver!

Liquids entering the housing of the device can cause a short-circuit and damage the electronics.

- ▶ Keep all liquids away from the diversity receiver.
- ▶ Do not use any solvents or cleansing agents.

- ▶ Use a cloth to clean the diversity receiver from time to time.

Recommendations and tips

... for the diversity receiver

- Make sure that the antenna and the earphones cable do not cross.
- For best results, make sure that the transmitter sensitivity is correctly adjusted.

... for optimum reception

- Transmission range depends to a large extent on location and can vary from about 10 m to about 150 m. There should be a "free line of sight" between transmitting and receiving antennas.
- To avoid overloading the receiver, observe a minimum distance of 5 m between transmitting and receiving antennas.

... for multi-channel operation

- When operating a multi-channel system, you should only use the channels within one frequency bank. Each of the frequency banks "1" to "20" accommodates factory-preset frequencies which are intermodulation-free.
- The frequency banks "U1" to "U6" allow you to freely select and store receiving frequencies (see page 17).
- When using several transmitters simultaneously, interference can be avoided by maintaining a minimum distance of 20 cm between two transmitters.

If a problem occurs ...

Problem	Possible cause	Possible solution
Diversity receiver cannot be operated, "Locked" appears on the display panel	Lock mode is activated	Deactivate the lock mode (see page 10).
No operation indication	Batteries are flat or accupack is flat	Replace the batteries or recharge the accupack (see page 7).
No RF signal	Transmitter and receiver are not on the same channel	Set the transmitter and receiver to the same channel. Synchronize the transmitter with the receiver (see page 21).
	Transmission range is exceeded	Check the squelch threshold setting (see page 14). Reduce the distance between transmitter and receiver.
	RF signal is deactivated ("RF Mute")	Activate the RF signal (see the instruction manual of the transmitter).
RF signal available, no audio signal, "MUTE" appears on the display panel	Transmitter is muted	Cancel the muting (see the instruction manual of the transmitter).
	Receiver's squelch threshold is adjusted too high	Reduce the squelch threshold setting (see page 14).
	SR 300 IEM G3 transmitter is set to mono operation and therefore doesn't transmit a pilot tone	Deactivate the pilot tone evaluation (see page 18).
	SR 300 IEM G3 transmitter is set to stereo operation and therefore transmits a pilot tone	Activate the pilot tone evaluation (see page 18).
Audio signal has a high level of background noise	Transmitter sensitivity is adjusted too low	Adjust the transmitter sensitivity correctly (see the instruction manual of the transmitter).
Audio signal is distorted	Transmitter sensitivity is adjusted too high	Adjust the transmitter sensitivity correctly (see the instruction manual of the transmitter).
No access to a certain channel	During scanning, an RF signal has been detected on this channel and the channel has been locked	Set the transmitter operating on this channel to a different channel and redo the frequency preset scan (see page 14).
	During scanning, a transmitter of your system operating on this channel has not been switched off	Switch the transmitter off and redo the frequency preset scan (see page 14).

If a problem occurs that is not listed in the above table or if the problem cannot be solved with the proposed solutions, please contact your local Sennheiser partner for assistance.

To find a Sennheiser partner in your country, search at www.sennheiser.com under "Service & Support".

Specifications

RF characteristics

Modulation	wideband FM
Frequency ranges	516–558, 566–608, 606–648, 626–668, 734–776, 780–822, 823–865 MHz (A to E, G, GB, see page 3)
Receiving frequencies	1,680 frequencies, tuneable in steps of 25 kHz
	20 frequency banks, each with up to 16 factory-preset channels
	6 frequency banks, each with up to 16 user programmable channels
Switching bandwidth	42 MHz
Nominal/peak deviation	± 24 kHz/ ± 48 kHz
Receiver principle	adaptive diversity
Sensitivity (with HDX, peak deviation)	$< 4 \mu\text{V}$, typ. $1.6 \mu\text{V}$ for 52 dB _{A,rms} S/N
Adjacent channel rejection	typ. ≥ 65 dB
Intermodulation attenuation	typ. ≥ 70 dB
Blocking	≥ 80 dB
Squelch	Off, 5 to 25 dB μV , adjustable in steps of 2 dB
Pilot tone squelch	evaluation can be switched off

AF characteristics

Compander system	Sennheiser HDX
S/N ratio (1 mV, peak deviation)	approx. 90 dB
THD	$\leq 0.9\%$
Output power at 2.4 V, 5 % THD, nominal deviation	2 x 100 mW at 32 Ω
High Boost	+8 dB at 80 kHz
Limiter	-18 dB to -6 dB, adjustable in steps of 6 dB, can be switched off

Overall device

Temperature range	-10°C to +55°C
Power supply	2 AA size batteries, 1.5 V or BA 2015 accupack
Nominal voltage	2.4 V ---
Power consumption:	
• at nominal voltage	approx. 140 mA
• with switched-off receiver	$\leq 25 \mu\text{A}$
Operating time	approx. 4 to 6 hrs (depending on volume level)
Dimensions	approx. 82 x 64 x 24 mm
Weight (incl. batteries)	approx. 125 g

In compliance with

Europe



EMC: EN 301489-1/-9
Radio: EN 300422-1/-2
Safety: EN 60065

USA



47 CFR 15 subpart B

Approved by

Canada

Industry Canada RSS 123
IC 2099A-G3SREK300
limited to 698 MHz

Connector assignment

3.5 mm jack plug

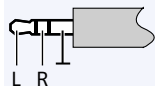

Manufacturer Declarations

Warranty

Sennheiser electronic GmbH & Co. KG gives a warranty of 24 months on this product.

For the current warranty conditions, please visit our web site at www.sennheiser.com or contact your Sennheiser partner.

In compliance with the following requirements

- WEEE Directive (2012/19/EU)



Please dispose of the diversity receiver at the end of its operational lifetime by taking it to your local collection point or recycling center for such equipment.

- Battery Directive (2006/66/EC)



The supplied batteries or rechargeable batteries can be recycled. Please dispose of them as special waste or return them to your specialist dealer. In order to protect the environment, only dispose of exhausted batteries.

CE Declaration of Conformity

- RoHS Directive (2011/65/EU)

• **CE 0682**

- R&TTE Directive (1999/5/EC)

The declarations are available at www.sennheiser.com.

Before putting the product into operation, please observe the respective country-specific regulations.

Statements regarding FCC and Industry Canada

This device complies with Part 15 of the FCC Rules and with RSS-123 of Industry Canada. Operation is subject to the following two conditions: (1) this device may not cause harmful interference, and (2) this device must accept any interference received, including interference that may cause undesired operation.

This equipment has been tested and found to comply with the limits for a Class B digital device, pursuant to Part 15 of the FCC Rules. These limits are designed to provide reasonable protection against harmful interference in a residential installation. This equipment generates, uses and can radiate radio frequency energy and, if not installed and used in accordance with the instructions, may cause harmful interference to radio communications. However, there is no guarantee that interference will not occur in a particular installation. If this equipment does cause harmful interference to radio or television reception, which can be determined by turning the equipment off and on, the user is encouraged to try to correct the interference by one or more of the following measures:

- Reorient or relocate the receiving antenna.
- Increase the separation between the equipment and receiver.
- Connect the equipment into an outlet on a circuit different from that to which the receiver is connected.
- Consult the dealer or an experienced radio/TV technician for help.

This class B digital device complies with the Canadian ICES-003.

Changes or modifications made to this equipment not expressly approved by Sennheiser electronic Corp. may void the FCC authorization to operate this equipment.

Before putting the product into operation, please observe the respective country-specific regulations!



Sennheiser electronic GmbH & Co. KG

Am Labor 1, 30900 Wedemark, Germany
www.sennheiser.com

Publ. 04/16, 549123/A02